

## Safety Information

Ask a qualified professional such as a licensed general contractor to install your range hood. Electrical wiring must be installed, insulated, and grounded by a licensed electrician familiar with your local codes and regulations. If you don't have this background, do not install the hood yourself. Poor installation or electrical work may result in an injury.

- Range hoods can be heavy to mount, so always ask a friend for help.
- Wear protective gloves when handling the range hood and its filters. The edges can be sharp.
- For residential use only. Do not install your hood in a restaurant or other commercial environment. Our hoods do not abide by the rules and regulations for commercial use.
- Do not use your hood to vent hazardous or explosive materials and vapors. This is incredibly dangerous and may result in serious injury.
- When cleaning the unit, make sure the power is turned off.
- When troubleshooting or replacing the touch panel, circuit board, or other electrical components, turn the range hood off.
- Check your local codes and regulations to see what type of ductwork is required. Some codes require rigid metal ductwork. Do not use flex duct for your range hood, as it can wear down quickly. Air may escape into your walls or attic.
- Never vent your ducted hood into an attic, joists in your ceiling, or a soffit. Always vent the hood to the outside to keep grease, smoke, and unwanted contaminants out of your home.
- Avoid electrical wiring when drilling a hole into your wall or ceiling for ductwork.
- Clean or replace old ductwork with new rigid ductwork to prevent potential grease fires and increase the efficiency of your range hood.
- Seal all joints in your duct system with aluminum tape to prevent air from escaping in your walls or attic.
- Check your local regulations to determine if you need make-up air. When a range hood vents air out of your home, that air has to be replaced. If you operate a powerful range hood (600+ CFM) in a small kitchen, you may need makeup air. We do not sell makeup air kits.
- Clean your range hood filters, grease trays, and the range hood every few weeks. Heavy grease buildup shortens the life of your hood and it may lead to a grease fire.
- All Proline range hoods are ETL certified. They meet all industry standards and regulations to ensure your safety.
- Use the high setting on your range hood to vent heavy smoke or heat in case of emergency. Otherwise, use the lower settings to prolong the life of your hood.
- While your range hood is on, do not leave your cooking area unattended.
- When cooking with oils, do not heat them past their smoke point. If oil starts smoking, turn off the burner and discard any food that came into contact with it. Do not use Extra Virgin Olive Oil in high heat, since it starts to smoke at around 300° Fahrenheit.

### In the event of a grease fire:

- Smother the flames with a large lid, pan, or baking sheet. If the fire is small, smother it with baking soda or salt. For larger fires, use a fire extinguisher.
- Turn off all burners.
- Do not touch a flaming pan. This may result in serious burns.
- Keep all flammable materials away from the grease fire. This may include nail polish remover, flour, rubbing alcohol, and hand sanitizer, among other household items.
- Do not pour water on a grease fire. Water will spread the oil around, making the fire more potent and dangerous. Wet towels and rags will also spread the oil, so avoid using these as well.
- If you cannot contain the fire, call the fire department immediately.

## Warranty Information

All of our range hoods have a three-year warranty. For the first year, we cover parts and labor. This doesn't include installation.

For the second and third years of your warranty, we'll cover parts only.

This warranty covers every part of your range hood besides the following:

- Range hood filters
- Range hood lights
- Any dents, dings, scratches, or other damage to the outside of the hood

If you're outside of the warranty and your hood is not working properly, call us at (877) 901-5530 and we'll help you resolve your issue. We can typically help fix your Proline range hood at a reasonable price so you don't have to replace the whole thing.

### Return Policy

If your range hood is damaged, we accept returns under certain conditions. You can return the hood within 14 days after it was received. If you return the hood inside this 14-day window, it doesn't cost you anything unless the order is undamaged freight. Then, you have to pay for shipping and a restocking fee.

When you receive your hood, be sure to inspect it before the 14-day window expires. Otherwise, you'll be stuck with a damaged range hood.

After that 14 day period and up to 30 days after you receive your hood, you can still return it. But you'll be responsible for a 20% restocking fee as well as the return shipping.

**Do not install the hood if it is damaged. We don't accept returns on hoods that are already installed.**

Outside of the 30-day period after you receive your hood, you can't return it.

If you bought your hood for a renovation project that's a few months out, remember to inspect it within 14 days of delivery to make sure it's in good condition.



2179 300 W, South Salt Lake, UT 84115  
(877) 901-5530  
support@prolinerangehoods.com  
prolinerangehoods.com  
Our support team hours are: Mon-Fri 8:30 am – 5:00 pm MST

## INSTALLATION GUIDE

# Under Cabinet Hoods

Scan for video installation guide 

### Before the Installation

#### 1. Check the contents of your box.

They should include, depending on the specific model of your hood:

- Range hood
- Wall mounting bracket
- Hardware packet with screws and anchors
- Transition duct

As you unpack your hood, remove any protective film from chimney sleeves, the filters, or the range hood before installation.

#### 2. Inspect your range hood.

- Plug in and test controls, lights, and fan.
- Inspect for any damage caused during shipping.
- Within 14 days of receiving the hood, call us at (877) 901-5530 or email support@prolinerangehoods.com to report any damage.

**NOTE: Do not install the hood if it's damaged or you're unsatisfied with it.**

#### 3. Make sure you can run power to the hood.

Before you begin the installation, ensure that you can run electricity to it without too much trouble. Make sure you know where you will plug in your vent hood and that you have the necessary extension cords before you proceed with the installation:

### Under Cabinet Range Hood Installation

#### What You Will Need

- Power drill
- Screwdriver
- Drill bits
- Tape measure
- Masking tape
- Pencil or marker
- Metal or aluminum HVAC tape
- Level
- Wall anchors\*
- Scissors or box Cutter

**The range hood needs to be installed to secure studs or supports.**

**\*Wall anchors can be used for additional support and will vary depending on the wall material and the weight of the range hood being installed.**

**If you missed a stud when installing wall anchors, you need to drill at least one screw through the back of the hood into a stud for additional support. We recommend supporting the hood with two to three screws.**

For even more support, you can drill through the sides or top of your cabinetry. But you still must secure your hood to a stud.

### Install Ductwork

#### 1. Plan where your ductwork will be located.

- Install your ductwork in the shortest unobstructed path to the outside of your home.
- Select a path that avoids studs, electrical wires, and other obstacles in your walls.

#### Venting Options

The best option is to vent vertically through the roof if possible, since hot air rises. See the diagram below.

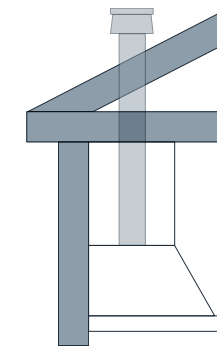

Or, vent through a side wall if you cannot vent directly above your hood.

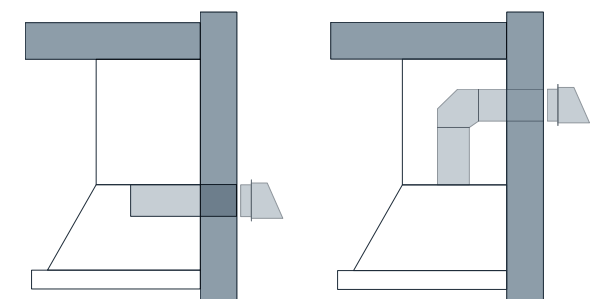

2179 300 W, South Salt Lake, UT 84115  
Call (877) 901-5530  
support@prolinerangehoods.com  
prolinerangehoods.com  
Our Support team hours are: Mon-Fri 8:30 am - 5:00 pm MST

### Best Practices when Ducting Your Range Hood

- Include at least 18" straight from the transition piece before using an elbow in the duct.
- Make sure there is at least 24" of straight duct between other elbows.
- Use rigid galvanized steel or metal HVAC ducting only.
- Do not terminate the vent system into an attic, or another enclosed area.
- Do not use 4" (10.2 cm) laundry-type wall caps.
- Do not use plastic flexible duct.
- Do not use more than 30' of ductwork.
- Do not reduce the diameter of your ductwork from the hood outlet size. This will lead to poor performance.
- A round duct is more efficient than a rectangular duct. Both are viable choices, but if you have the option, use round ductwork.
- For each elbow in your duct, reduce the total length of your duct run by 10'.
- Do not use more than two elbows in your ductwork. The fewer the elbows, the better.

### 2. Cut a hole 1-2 inches larger than your duct diameter in your ceiling or wall.

- Once you have decided whether to run your duct vertically or horizontally, cut the hole for your ductwork.
- Use the duct transition piece as a guide to determine the size of this hole.
- Trace around the transition on your cabinets or wall.
- Use your sheetrock saw to cut the hole 1-2 inches larger than the transition.

### 3. Thread the ductwork from the exterior of your home to the range hood.

- Your attic is generally the easiest place to thread ductwork.
- Otherwise, you may have to choose a couple of areas to cut out access points in your wall.

**Before you cut holes in your home, if you aren't certain of what is inside the wall where you are cutting, consult a contractor.**

### 4. Drop your ductwork through the ceiling.

Measure the following:

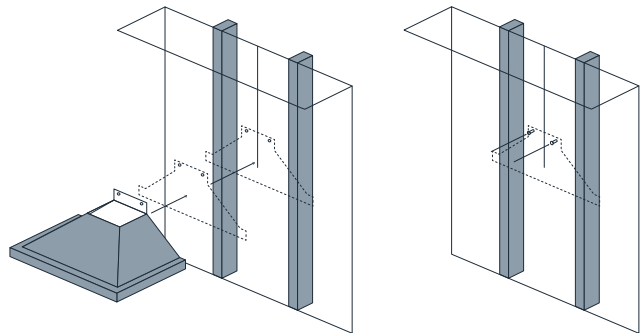

Now that you've installed your ductwork, draw these markings on the installation area wall:

- The centerline of the installation area.
- The location of wall studs nearest to the center line. (One on each side).

**Typically, studs are near outlets. Most homes today are on 16-inch centers, so when you find the first stud, measure 16 inches away to find the next stud.**

Or, knock on the wall and listen for a solid sound.

- A horizontally level line 28-36" above the cooktop surface. This is where the bottom of your range hood will be.

## Step 1

Find and mark where you will mount your range hood.

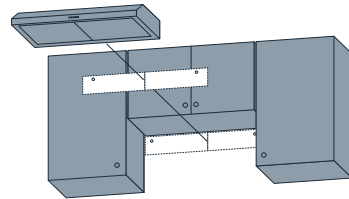

- Trace the outline of your hood on the flat piece of its cardboard box.
- Find the mounting holes and center point of the hood (halfway between the mounting holes) and mark them on the cardboard panel.
- Carefully cut out the cardboard outline.
- Tape the cardboard cutout panel to the wall leaving a small gap (roughly 1/8") below the bottom of the cabinet. Match the center point with the centerline of the installation area.
- Poke holes through the mounting points on the cardboard to mark them on the wall, then remove the cardboard.

Mount your hood 28-36" between the top of the cooking surface and the bottom of the hood. Mount your outdoor hood 36-42" over a BBQ grill.

- **Hoods mounted below 28" from your cooktop may be susceptible to heat or fire damage.**
- **Hoods mounted above 36" from your cooktop will perform poorly and become inefficient.**

## Step 2

Install wall anchors and mounting screws where you will hang the range hood.

- Pre-drill the mounting holes where your marks are with the correct size drill bit.
- If you're using wall anchors, insert the wall anchors into the holes.
- Screw in the mounting screws, leaving roughly a 1/4" gap. This gap will be used to hang the hood in Step 2.

Hang the range hood

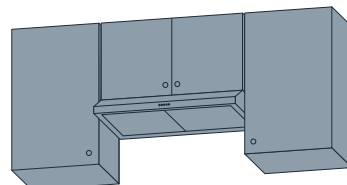

Carefully hang the hood on the mounting screws in place from Step 2. The bottom of the hood should match up with the horizontal line marked on the wall.

Our PLJW 185 model has perforated plates on the top and back of the hood that need to be removed before installation. If you have a 185, remove the plates first. Then, screw the top of the hood into the bottom of the cabinet above.

If the plates or knockouts in the back of the hood do not align with studs, drill holes in the back of the hood lining up with the wall studs that have been previously marked.

Secure the hood to the wall studs using the screws included in the hardware bag.

## Step 3

Attach and seal the ductwork to the range hood.

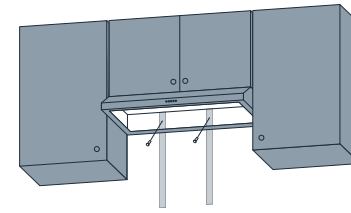

- Attach the duct transition piece to the top of your range hood. The ductwork should already be punched horizontally or vertically, ready to hook up to the range hood before beginning the installation.
- Use aluminum tape to seal the ductwork to the transition piece. For the best results, make sure that you seal the duct air tight.
- Attach a wall or roof cap to the exterior wall or roof. A cap helps keep debris and dirt from entering your duct. Use caulking to seal exterior openings around the wall or roof cap.

## After the Installation - Final Steps

Now you just need to do a few quick things to ensure that your installation went smoothly.

**Tighten screws that hang the range hood.**

- Next, for added support, you can tighten your screws. If you still want more support, you can add a grabber or self-tapping screw through your mounting bracket or range hood into your stud. You can also add grabber screws into the side of your range hood through your wall if you have the same design as in our warehouse.

**Check that your hood is horizontally level.**

- The first thing is to set your level up against the front of your range hood to make sure that it is perfectly horizontal.

**Check your front-to-back alignment (vertical level).**

- Finally, check your front-to-back level to ensure that your wall is perfectly vertical. Most people don't have any problems with the front-to-back alignment.
- But if you do, you may need to install shims – or spacers between your wall and range hood – behind your hood to fix the alignment.

**Assemble and insert baffle filters and the grease tray (if included).**

- If your hood comes with a grease tray, slide this into the back of the range hood before inserting the filters.
- Then, angle the filters to set them into the back of your hood first and slide them to the front of the hood.

**NOTE: Be careful when handling the filters. They may be sharp.**

- Some filters have handles and a catch mechanism on the front of the filter. If your filter comes with these parts, insert the screws for each part of the handle through the screw hole.
- Then tighten them by hand.
- The catch mechanism screws into the back of the hood. You can do this by hand.

## Run Power to the Hood

- All range hoods come with a 4' cord. If this isn't long enough, you can use an extension cord. Plug your hood into the nearest outlet.
- Power the hood by connecting the three pronged plug to a nearby electrical outlet or by hardwiring the hood to a power source. Always consult an electrician before directly wiring a hood to a power source.

**That wraps up your wall range hood installation!  
Great work!**

**We are happy to help you with any questions or concerns you may have. Please create a ticket, email us at [support@prolinerangehoods.com](mailto:support@prolinerangehoods.com) or call our support line at (877) 901-5530 to talk to a live representative.**